

## 1/4" NPT Brass Body 2-Way Direct Acting Normally Closed

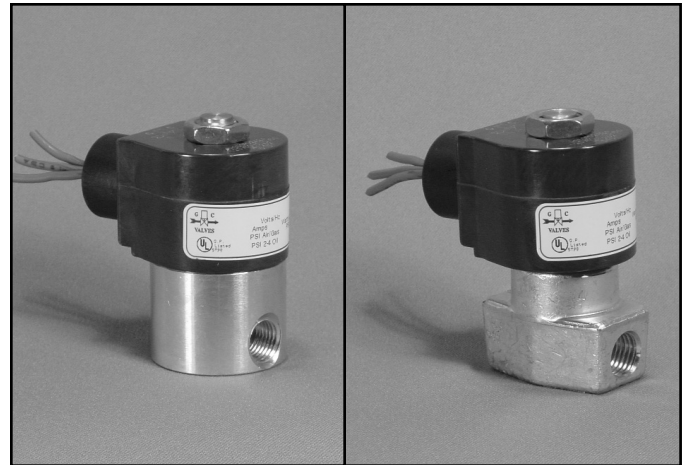

Materials	Seals:	Nitrile, Viton®, Ethylene Propylene, Teflon®, Rulon
	Orifice:	Stainless Steel
Electrical	Standard Housing:	Encapsulated Waterproof Conduit (NEMA 4/4X)
	Optional Housings:	Metallic Conduit, Explosion-proof (NEMA 7), Grommet, Open Frame, Junction Box (single or dual knockouts), DIN; Contact GC Valves Customer Service for others.
	Standard Voltages:	24, 120, 240 AC 60 Hz; 50 Hz available 6, 12, 24 DC; Contact GC Valves Customer Service for Additional Voltages.
	Voltage Tolerance:	±10% of applicable voltage
	Coil Classes:	F, H, N
	Standard Lead Length:	24 inch
Operating Temperature	Ambient (Nominal):	32°F to 125°F
Mounting	Position:	Any
Approvals*	Agency:	UL Safety Shutoff, UL Listed, UL Recognized, CSA Approved, FM Certified

\* Not available for all variations

© Registered Trademark of DuPont Co.

### Dimensions/Weight

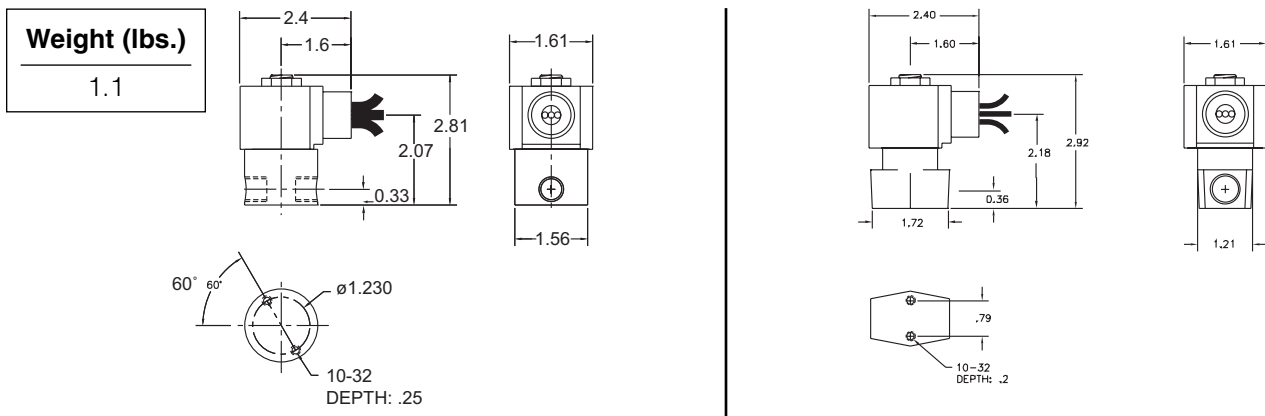

GC Valves Customer Service: 800-828-0484 (7:30am to 4pm ET) or 800-582-4232 (7:30am to 4pm PT)



# S311 – 1/4" NPT, Brass Body, Normally Closed

## Valve Selection List

Normally Closed

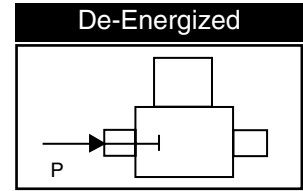
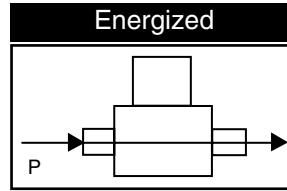
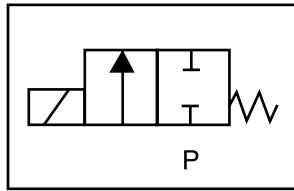

Pipe Size NPT	Orifice Size in.	C <sub>v</sub>	Minimum	Operating Pressure Differential (psi)								Max Fluid Temp. °F	Seal Material	Power Consumption (Watts)		Model Code (120V/60HZ — 110V/50HZ Shown)	
				Maximum										AC	DC		
				Air/Gas		Water		Light Oil		Steam*							
				AC	DC	AC	DC	AC	DC	AC	DC			AC	DC	AC	DC
1/4	1/32	.03	0	2000	2000	2000	2000	—	—	150*	150*	295	EPR	8	9	S311GF02C8AC1	
	3/64	.05	0	770	420	770	420	—	—	150*	150*	295	EPR	8	9	S311GF02C8BC3	
	1/16	.10	0	560	185	560	185	—	—	150*	150*	295	EPR	8	9	S311GF02C8BC5	
	5/64	.15	0	400	150	400	150	—	—	150*	150*	295	EPR	8	9	S311GF02C8BC7	
	3/32	.21	0	300	130	300	130	—	—	150*	130*	295	EPR	8	9	S311GF02C8BC9	
	7/64	.29	0	210	90	210	90	—	—	150*	90*	295	EPR	8	9	S311GF02C8BD3	
	1/8	.32	0	155	60	155	60	—	—	150*	60*	295	EPR	8	9	S311GF02C8BD5	
	5/32	.43	0	105	35	105	35	—	—	105*	35*	295	EPR	8	9	S311GF02C8BD7	
	3/16	.49	0	75	20	75	20	—	—	75*	20*	295	EPR	8	9	S311GF02C8BE1	
	1/4	.85	0	35	15	35	15	—	—	35*	15*	295	EPR	8	9	S311GF02C9BE7	
	9/32	1.0	0	20	10	20	10	—	—	20*	10*	295	EPR	8	9	S311GF02C9BF1	
	3/8	1.1	0	15	5	15	5	—	—	15*	5*	295	EPR	8	9	S311GF02C9BF5	
1/4	1/32	.03	0	2000	2000	2000	2000	2000	2000	—	—	180	Nitrile	8	9	S311GF02N8AC1	
	3/64	.05	0	770	420	770	420	770	420	—	—	180	Nitrile	8	9	S311GF02N8BC3	
	1/16	.10	0	560	185	560	185	560	185	—	—	180	Nitrile	8	9	S311GF02N8BC5	
	5/64	.15	0	400	150	400	150	400	150	—	—	180	Nitrile	8	9	S311GF02N8BC7	
	3/32	.21	0	300	130	300	130	300	130	—	—	180	Nitrile	8	9	S311GF02N8BC9	
	7/64	.29	0	210	90	210	90	210	90	—	—	180	Nitrile	8	9	S311GF02N8BD3	
	1/8	.32	0	155	60	155	60	155	60	—	—	180	Nitrile	8	9	S311GF02N8BD5	
	5/32	.43	0	105	35	105	35	105	35	—	—	180	Nitrile	8	9	S311GF02N8BD7	
	3/16	.49	0	75	20	75	20	75	20	—	—	180	Nitrile	8	9	S311GF02N8BE1	
	1/4	.85	0	35	15	35	15	35	15	—	—	180	Nitrile	8	9	S311GF02N9BE7	
	9/32	1.0	0	20	10	20	10	20	10	—	—	180	Nitrile	8	9	S311GF02N9BF1	
	3/8	1.1	0	15	5	15	5	15	5	—	—	180	Nitrile	8	9	S311GF02N9BF5	
1/4	1/32	.03	0	2000	2000	2000	2000	2000	2000	—	—	230	Viton	8	9	S311GF02V8AC1	
	3/64	.05	0	770	420	770	420	770	420	—	—	230	Viton	8	9	S311GF02V8BC3	
	1/16	.10	0	560	185	560	185	560	185	—	—	230	Viton	8	9	S311GF02V8BC5	
	5/64	.15	0	400	150	400	150	400	150	—	—	230	Viton	8	9	S311GF02V8BC7	
	3/32	.21	0	300	130	300	130	300	130	—	—	230	Viton	8	9	S311GF02V8BC9	
	7/64	.29	0	210	90	210	90	210	150	—	—	230	Viton	8	9	S311GF02V8BD3	
	1/8	.32	0	155	60	155	60	155	60	—	—	230	Viton	8	9	S311GF02V8BD5	
	5/32	.43	0	105	35	105	35	105	35	—	—	230	Viton	8	9	S311GF02V8BD7	
	3/16	.49	0	75	20	75	20	75	20	—	—	230	Viton	8	9	S311GF02V8BE1	
	1/4	.85	0	35	15	35	15	35	15	—	—	230	Viton	8	9	S311GF02V9BE7	
	9/32	1.0	0	20	10	20	10	20	10	—	—	230	Viton	8	9	S311GF02V9BF1	
	3/8	1.1	0	15	5	15	5	15	5	—	—	230	Viton	8	9	S311GF02V9BF5	

\* Class H Coil Recommended for Steam and Other High Temperature Applications

GC Valves Customer Service: 800-828-0484 (7:30am to 4pm ET) or 800-582-4232 (7:30am to 4pm PT)

# S311 – 1/4" NPT, Brass Body, Normally Closed



## Valve Selection List

Normally Closed

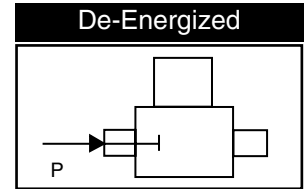
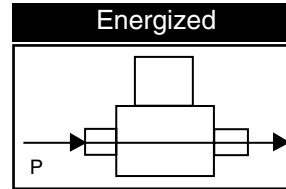
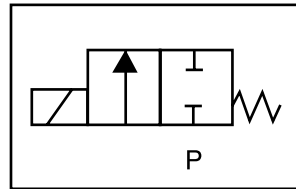

Pipe Size NPT	Orifice Size in.	C <sub>v</sub>	Minimum	Operating Pressure Differential (psi)								Max Fluid Temp. °F	Seal Material	Power Consumption (Watts)		Model Code (120V/60HZ — 110V/50HZ) Shown
				Maximum										AC	DC	
				Air/Gas		Water		Light Oil		Steam*						
				AC	DC	AC	DC	AC	DC	AC	DC			AC	DC	Brass Body
1/4	1/32	.03	0	2000	2000	2000	2000	2000	2000	150*	150*	366	Rulon	8	9	S311GF02R8AC1
	3/64	.05	0	770	420	770	420	770	420	150*	150*	366	Rulon	8	9	S311GF02R8BC3
	1/16	.10	0	560	185	560	185	560	185	150*	150*	366	Rulon	8	9	S311GF02R8BC5
	5/64	.15	0	400	150	400	150	400	150	150*	150*	366	Rulon	8	9	S311GF02R8BC7
	3/32	.21	0	300	130	300	130	300	130	150*	130*	366	Rulon	8	9	S311GF02R8BC9
	7/64	.29	0	210	90	210	90	210	90	150*	90*	366	Rulon	8	9	S311GF02R8BD3
	1/8	.32	0	155	60	155	60	155	60	150*	60*	366	Rulon	8	9	S311GF02R8BD5
	5/32	.43	0	105	35	105	35	105	35	105*	35*	366	Rulon	8	9	S311GF02R8BD7
	3/16	.49	0	75	20	75	20	75	20	75*	20*	366	Rulon	8	9	S311GF02R8BE1
	1/4	.85	0	35	15	35	15	35	15	35*	15*	366	Rulon	8	9	S311GF02R9BE7
	9/32	1.0	0	20	10	20	10	20	10	20*	10*	366	Rulon	8	9	S311GF02R9BF1
3/8	1.1	0	15	5	15	5	15	5	15*	5*	366	Rulon	8	9	S311GF02R9BF5	
1/4	1/32	.03	0	2000	2000	2000	2000	2000	2000	150*	150*	366	Teflon	8	9	S311GF02T8AC1
	3/64	.05	0	770	420	770	420	770	420	150*	150*	366	Teflon	8	9	S311GF02T8BC3
	1/16	.10	0	560	185	560	185	560	185	150*	150*	366	Teflon	8	9	S311GF02T8BC5
	5/64	.15	0	400	150	400	150	400	150	150*	150*	366	Teflon	8	9	S311GF02T8BC7
	3/32	.21	0	300	130	300	130	300	130	150*	130*	366	Teflon	8	9	S311GF02T8BC9
	7/64	.29	0	210	90	210	90	210	90	150*	90*	366	Teflon	8	9	S311GF02T8BD3
	1/8	.32	0	155	60	155	60	155	60	150*	60*	366	Teflon	8	9	S311GF02T8BD5
	5/32	.43	0	105	35	105	35	105	35	105*	35*	366	Teflon	8	9	S311GF02T8BD7
	3/16	.49	0	75	20	75	20	75	20	75*	20*	366	Teflon	8	9	S311GF02T8BE1
	1/4	.85	0	35	15	35	15	35	15	35*	15*	366	Teflon	8	9	S311GF02T9BE7
	9/32	1.0	0	20	10	20	10	20	10	20*	10*	366	Teflon	8	9	S311GF02T9BF1
3/8	1.1	0	15	5	15	5	15	5	15*	5*	366	Teflon	8	9	S311GF02T9BF5	

\* Class H Coil Recommended for Steam and Other High Temperature Applications



# S311 – 1/4" NPT, Brass Body, Normally Closed

## Part Numbering

1	2	3	4	5	6	7	8	9	10	11	12	13
<b>S</b>	<b>3</b>	<b>1</b>	<b>1</b>	<b>G</b>	<b>F</b>	<b>0</b>	<b>2</b>	<b>C</b>	<b>8</b>	<b>B</b>	<b>C</b>	<b>1</b>
Series			Operating Mode	Housing*	Coil Class*	Voltage*		Seal Material	Body Material	Pipe Connection	Orifice Size	
S31			1: Normally Closed	G: Conduit	F: Class F H: Class H	02: 120/60 110/50		C: EPR N: Nitrile V: Viton R: Rulon T: Teflon	8: Brass 9: Forged Brass	B: 1/4" NPT	C1: 1/32" C3: 3/64" C5: 1/16" C7: 5/64" C9: 3/32" D3: 7/64" D5: 1/8" D7: 5/32" E1: 3/16" E7: 1/4" F1: 9/32" F5: 3/8" <sup>®</sup>	
* See the "Engineering Guide" for additional voltages, variations and options.												

<sup>®</sup>Brass

## Coil Data

Coil Family	
Type	Size
All	S3

Frequency (Hz)	60	50
Nominal Power (VA)	Inrush	36
	Holding	13

GC Valves Customer Service: 800-828-0484 (7:30am to 4pm ET) or 800-582-4232 (7:30am to 4pm PT)