



# S30 Series

- 1/4" NPT
- Brass Body
- 2-Way Direct Acting
- Normally Closed



Materials	Seals:	Nitrile, FKM, Ethylene Propylene, PTFE, Rulon
	Orifice:	Brass (Stainless orifice is available)
Electrical	Standard Housing:	Encapsulated Waterproof Conduit (NEMA 4X)
	Optional Housings:	Metal Conduit, Explosion-Proof (NEMA 7), Grommet Open Frame, Junction Box (single or dual knockouts), DIN, Contact GC Valves Customer Svc. For others.
	Standard Voltages:	24, 120, 240, AC, 60 and/or 50 Hz. Available 6, 12, 24 DC Contact GC Valves Customer Svc. For Additional Voltages
	Voltage Tolerance:	± 10% of applicable voltage
	Coil Classes:	F, H, N
	Standard Lead Length:	24 inches
Operating Temperature	Ambient (Nominal):	32° F to 125° F
Mounting	Position:	Any
Approvals*	Agency:	UL Safety, UL Listed, UL Recognized, CSA Approved

\* Not available for all variations

## Dimensions / Weight

<b>Weight (Lbs.)</b>
1.1

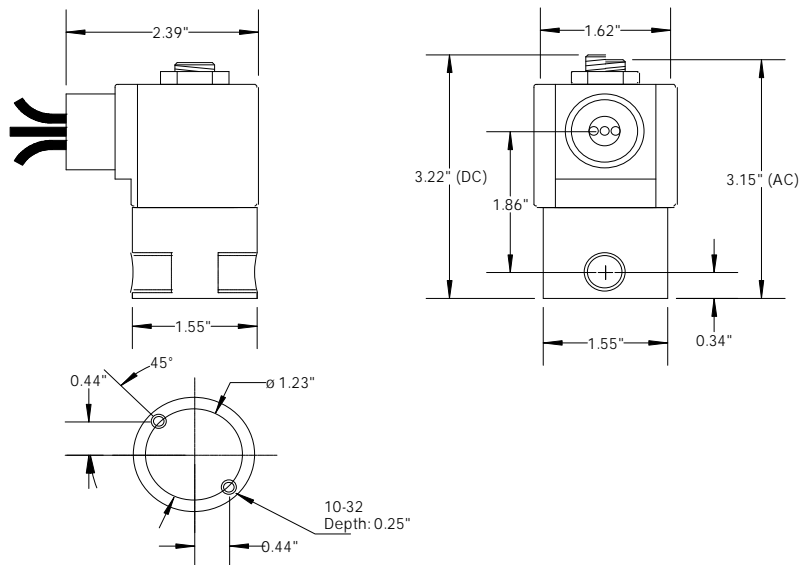

GC Valves Customer Service: 800-828-0484 (7:30 AM to 5:00 PM ET)



# S301 - 1/4" NPT, Brass Body, Normally Closed

## Valve Selection List

Normally Closed

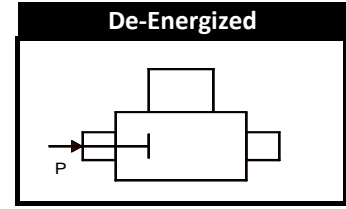
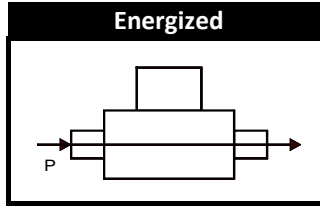
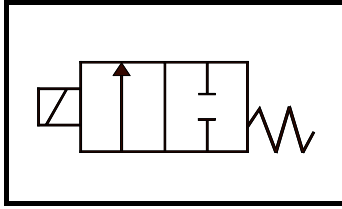

Pipe Size	Orifice Size	Cv	Operating Pressure Differential (PSI)								Max. Fluid Temp. °F	Seal Material	Power Consumption (Watts)		Model Code (120V/60HZ-110V/50HZ) Shown	
			Minimum	Maximum									AC	DC		Brass Body
				Air/Gas		Water		Light Oil		Steam*						
				AC	DC	AC	DC	AC	DC	AC					DC	
NPT	In.															
1/4	1/32	.03	0	2400	2400	2400	2400	---	---	150	150	295	EPR	10	10	S301GF02C8BC1
	3/64	.05	0	1050	1000	1050	1000	---	---	150	150	295	EPR	10	10	S301GF02C8BC3
	1/16	.10	0	700	300	700	300	---	---	150	150	295	EPR	10	10	S301GF02C8BC5
	5/64	.15	0	500	240	500	240	---	---	150	150	295	EPR	10	10	S301GF02C8BC7
	3/32	.21	0	400	200	400	200	---	---	150	150	295	EPR	10	10	S301GF02C8BC9
	7/64	.29	0	350	170	350	170	---	---	150	150	295	EPR	10	10	S301GF02C8BD3
	1/8	.36	0	200	140	200	140	---	---	150	140	295	EPR	10	10	S301GF02C8BD5
	5/32	.44	0	150	100	150	100	---	---	150	100	295	EPR	10	10	S301GF02C8BD7
	3/16	.65	0	100	70	100	70	---	---	100	70	295	EPR	10	10	S301GF02C8BE1
	1/4	.85	0	50	20	50	20	---	---	50	20	295	EPR	10	10	S301GF02C8BE7
9/32	1.0	0	35	15	35	15	---	---	35	15	295	EPR	10	10	S301GF02C8BF1	
1/4	1/32	.03	0	2400	2400	2400	2400	2400	2400	---	---	180	Nitrile	10	10	S301GF02N8BC1
	3/64	.05	0	1050	1000	1050	1000	1050	1000	---	---	180	Nitrile	10	10	S301GF02N8BC3
	1/16	.10	0	700	300	700	300	700	300	---	---	180	Nitrile	10	10	S301GF02N8BC5
	5/64	.15	0	500	240	500	240	500	240	---	---	180	Nitrile	10	10	S301GF02N8BC7
	3/32	.21	0	400	200	400	200	400	200	---	---	180	Nitrile	10	10	S301GF02N8BC9
	7/64	.29	0	350	170	350	170	350	170	---	---	180	Nitrile	10	10	S301GF02N8BD3
	1/8	.36	0	200	140	200	140	200	140	---	---	180	Nitrile	10	10	S301GF02N8BD5
	5/32	.44	0	150	100	150	100	150	100	---	---	180	Nitrile	10	10	S301GF02N8BD7
	3/16	.65	0	100	70	100	70	100	70	---	---	180	Nitrile	10	10	S301GF02N8BE1
	1/4	.85	0	50	20	50	20	50	20	---	---	180	Nitrile	10	10	S301GF02N8BE7
9/32	1.0	0	35	15	35	15	35	15	---	---	180	Nitrile	10	10	S301GF02N8BF1	
1/4	1/32	.03	0	2400	2400	2400	2400	2400	2400	---	---	230	FKM	10	10	S301GF02V8BC1
	3/64	.05	0	1050	1000	1050	1000	1050	1000	---	---	230	FKM	10	10	S301GF02V8BC3
	1/16	.10	0	700	300	700	300	700	300	---	---	230	FKM	10	10	S301GF02V8BC5
	5/64	.15	0	500	240	500	240	500	240	---	---	230	FKM	10	10	S301GF02V8BC7
	3/32	.21	0	400	200	400	200	400	200	---	---	230	FKM	10	10	S301GF02V8BC9
	7/64	.29	0	350	170	350	170	350	170	---	---	230	FKM	10	10	S301GF02V8BD3
	1/8	.36	0	200	140	200	140	200	140	---	---	230	FKM	10	10	S301GF02V8BD5
	5/32	.44	0	150	100	150	100	150	100	---	---	230	FKM	10	10	S301GF02V8BD7
	3/16	.65	0	100	70	100	70	100	70	---	---	230	FKM	10	10	S301GF02V8BE1
	1/4	.85	0	50	20	50	20	50	20	---	---	230	FKM	10	10	S301GF02V8BE7
9/32	1.0	0	35	15	35	15	35	15	---	---	230	FKM	10	10	S301GF02V8BF1	

GC Valves Customer Service: 800-828-0484 (7:30 AM to 5:00 PM ET)



# S301 - 1/4" NPT, Brass Body, Normally Closed

## Valve Selection List

Normally Closed

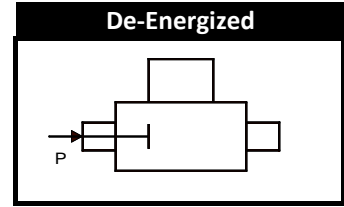
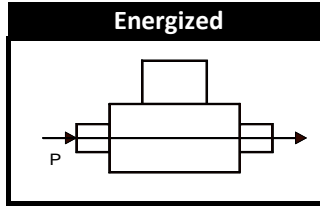
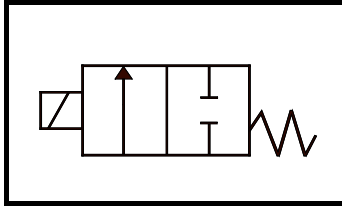

Pipe Size NPT	Orifice Size In.	Cv	Operating Pressure Differential (PSI)								Max. Fluid Temp. °F	Seal Material	Power Consumption (Watts)		Model Code (120V/60HZ-110V/50HZ) Shown	
			Minimum	Maximum									AC	DC		Stainless Steel Body
				Air/Gas		Water		Light Oil		Steam*						
				AC	DC	AC	DC	AC	DC	AC					DC	
1/4	1/32	.03	0	2400	2400	2400	2400	2400	2400	150	150	366	Rulon	10	10	S301GF02R8BC1
	3/64	.05	0	1050	1000	1050	1000	1050	1000	150	150	366	Rulon	10	10	S301GF02R8BC3
	1/16	.10	0	700	300	700	300	700	300	150	150	366	Rulon	10	10	S301GF02R8BC5
	5/64	.15	0	500	240	500	240	500	240	150	150	366	Rulon	10	10	S301GF02R8BC7
	3/32	.21	0	400	200	400	200	400	200	150	150	366	Rulon	10	10	S301GF02R8BC9
	7/64	.29	0	350	170	350	170	350	170	150	150	366	Rulon	10	10	S301GF02R8BD3
	1/8	.36	0	200	140	200	140	200	140	150	140	366	Rulon	10	10	S301GF02R8BD5
	5/32	.44	0	150	100	150	100	150	100	150	100	366	Rulon	10	10	S301GF02R8BD7
	3/16	.65	0	100	70	100	70	100	70	100	70	366	Rulon	10	10	S301GF02R8BE1
	1/4	.85	0	50	20	50	20	50	20	50	20	366	Rulon	10	10	S301GF02R8BE7
	9/32	1.0	0	35	15	35	15	35	15	35	15	366	Rulon	10	10	S301GF02R8BF1
1/4	1/32	.03	0	2400	2400	2400	2400	2400	2400	150	150	366	PTFE	10	10	S301GF02T8BC1
	3/64	.05	0	1050	1000	1050	1000	1050	1000	150	150	366	PTFE	10	10	S301GF02T8BC3
	1/16	.10	0	700	300	700	300	700	300	150	150	366	PTFE	10	10	S301GF02T8BC5
	5/64	.15	0	500	240	500	240	500	240	150	150	366	PTFE	10	10	S301GF02T8BC7
	3/32	.21	0	400	200	400	200	400	200	150	150	366	PTFE	10	10	S301GF02T8BC9
	7/64	.29	0	350	170	350	170	350	170	150	150	366	PTFE	10	10	S301GF02T8BD3
	1/8	.36	0	200	140	200	140	200	140	150	140	366	PTFE	10	10	S301GF02T8BD5
	5/32	.44	0	150	100	150	100	150	100	150	100	366	PTFE	10	10	S301GF02T8BD7
	3/16	.65	0	100	70	100	70	100	70	100	70	366	PTFE	10	10	S301GF02T8BE1
	1/4	.85	0	50	20	50	20	50	20	50	20	366	PTFE	10	10	S301GF02T8BE7
	9/32	1.0	0	35	15	35	15	35	15	35	15	366	PTFE	10	10	S301GF02T8BF1

GC Valves Customer Service: 800-828-0484 (7:30 AM to 5:00 PM ET)



# S301 - 1/4" NPT, Brass Body, Normally Closed

## Part Numbering

1	2	3	4	5	6	7	8	9	10	11	12	13
<b>S</b>	<b>3</b>	<b>0</b>	<b>1</b>	<b>G</b>	<b>F</b>	<b>0</b>	<b>2</b>	<b>C</b>	<b>8</b>	<b>B</b>	<b>C</b>	<b>1</b>
Series			Operating Mode	Housing*	Coil Class*	Voltage*		Seal Material	Body Material	Pipe Connection	Orifice Size	
S30			1: Normally Closed	G: Conduit	F: Class F H: Class H N: Class N	02: 120/60, 110/50		C: EPR V: FKM R: Rulon T: PTFE	8: Brass	B: 1/4" NPT	C1: 1/32" C3: 3/64" C5: 1/16" C7: 5/64" C9: 3/32" D5: 1/8" D7: 5/32" E1: 3/16" E7: 1/4" F1: 9/32"	
* See the "Engineering Guide" for additional voltages, variations and options.												

## Coil Data

Coil Family	
Type	Size
All	S4

Frequency (Hz)	60	50
Nominal Power (VA)	Inrush	46
	Holding	18

GC Valves Customer Service: 800-828-0484 (7:30 AM to 5:00 PM ET)